

NEEL 43

SAFETY	3	THE OWNER'S CABIN, AN INNOVATIVE CONCEPT	18
COMFORT	4	THE WATER ROOM	19
PERFORMANCE	5	NAVIGATION STATION	20
MANEUVERABILITY	6	BEDDINGS	21
CONSTRUCTION	7	FRONT CABINS	24
PRODUCTION ENVIRONMENTALLY FRIENDLY MANUFACTURING	8	TECHNICAL AND STORAGE AREAS	25
KEY POINTS	9	RIGGING AND MANEUVERS	28
FULL BEAM COCKPIT ®	10	TENDER LIFT	29
EASY CIRCULATION PLAN ONBOARD	11	NEEL-TRIMARANSHULL	
HELM STATION	12	VS.CATAMARANS AND MONOHULLS	30
RAISED HELM STATION	13	CHARACTERISTICS	31
MAIN DECK	14	CERTIFICATION	32
MODERN KITCHEN	15	OVERALL BEAM	33
INTEGRATE PLANCHA IN THE COCKPIT	16	POWER TO WEIGHT RATIO	34
	17	PRICE	35
		CHRISTENED BY A GREAT SAILOR	37

Why a NEEL trimaran is safer at sea ?

The width of NEEL trimarans is an important factor for **safety** on **the high seas** because it is a guarantee of **stability**.

On a catamaran the maximum righting moment occurs at 12° heeling, as shown on the stability curve.

This angle can be reached relatively easily when sailing in strong winds and heavy seas.

However, on a trimaran, this maximum righting moment does not occur until 27° heeling, therefore in normal multihull conditions of use, this angle is never reached.

For this reason, and thanks to the centered weight distribution, a trimaran is much more stable than a catamaran.

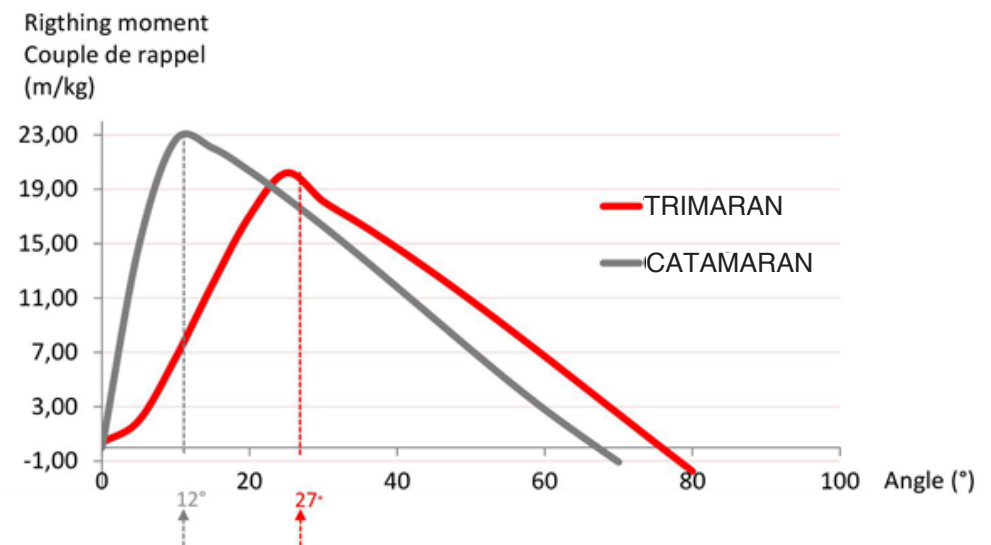

At 12° it is necessary to begin to shock the listening on a catamaran, whereas the trimaran is extremely on up to 27° heeling (*angle of heeling never reached anyway on a cruising multihull*). At 12° the trimaran is in a very comfortable sailing pace, while the catamaran is pushed to its limit of use.

Why a NEEL trimaran is more comfortable at sea?

Let's consider both the trimaran and the catamaran heeling by 12° which is the **safety angle** not to be exceeded on a catamaran. As shown in the graphics, the righting moment (GZ) is much higher on the trimaran than on the catamaran. A high GZ means more brutal and uncomfortable seakeeping. At this angle of heel the catamaran's GZ is double that of the trimaran.

Therefore, sailing the trimaran is much smoother than sailing the catamaran.

The trimaran has less roll motion than the catamaran, as the center of buoyancy is never far downwind like on a catamaran. Again **centered weight is the key to success and comfort**. In fact, all significant heavy equipment is located in the main central hull on a trimaran whereas it is distributed half and half in each hull on a catamaran.

The superiority of the trimaran is even more significant in heavy seas as shown on the illustration here.

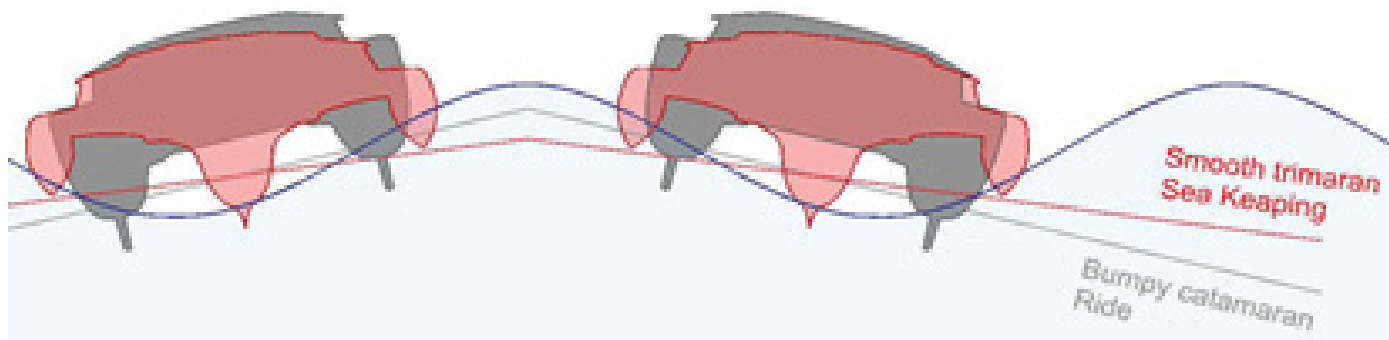
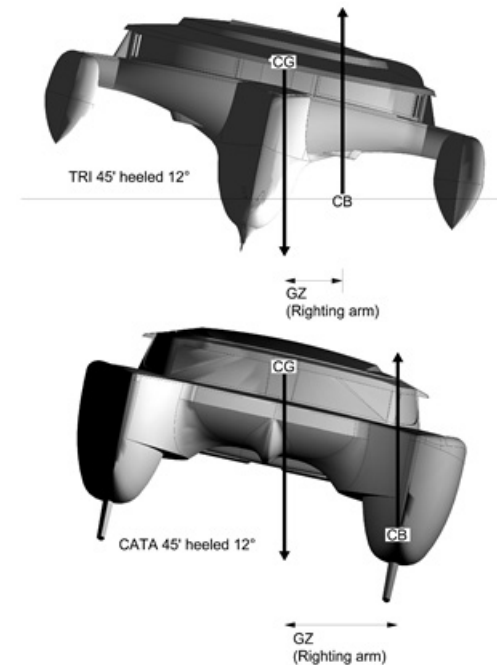

Why a NEEL trimaran is faster at sea?

As shown in offshore racing, the trimaran is significantly faster than monohulls or catamarans.

This is also true for cruising trimarans, as proven by the last ARC (Atlantic Rally for Cruisers) rally won by a NEEL 45 in December 2015 and by a NEEL 47 2019 and 2020.

The superiority of the trimaran is even more obvious when sailing upwind, especially due to the rig on a catamaran, the forestay pulls from the front beam, the mast compresses a central beam and the shrouds pull the two floats supporting the forestay and mast beam this platform deforms in many directions.

Consequently, it is then impossible to have a rigid forestay. On a trimaran, the forestay, mast and mainsail tension are structurally bonded to one strong, longitudinal beam the main hull. This configuration, as per a monohull allows for a rigid forestay and good performance up wind. Performance is also enhanced by the centered weight.

The extra speed of the trimaran is an additional safety factor.



Why a NEEL trimaran is more manoeuvrable?



NEEL trimarans are conceived for fast cruising.

With an average cruising speed of 10 knots, over **200 nautical miles** are easily achievable **each 24 hours**. Speeds from **15 to 18 knots** are often reached when the breeze freshens. Weight centering is managed in order to limit pitching. The centre hull is rockered to facilitate tacking.

Floats are of a stretched form to privilege **directional stability** and **passage through the sea** (thin bows). The rigging is directly derived from racing trimarans, thereby achieving full cruising speeds of **1.5 to 2 times** faster than conventional cruising yachts. The sail surface area is generous with some **17m² per tonne**. Finally, the trimaran configuration also facilitates **sustained speed under motor propulsion**. The low prismatic coefficient of the central hull means drag is very weak. The side floats are only very lightly in contact with the surface of the water.

The manoeuvres reported to the steering **station have been designed for navigation** with a reduced crew or even for **easy solo manoeuvres**.

- Choice of 2 possible rigs: **classic** or **carbon performance**
- Up to 3 **headsails** : genoa, staysail and asymmetrical spinnaker

An in-depth study

To optimise the **structure of NEEL trimarans**, we collaborated with TENSYL and Cabinet Lombard with whom we have previously worked on the structure of the racing trimaran TRILOGIC.

TENSYL and Cabinet Lombard have made a speciality of **the structural design of multi hull racing and cruising composites**. Sampling is determined from the most critical cases of offshore loading on the structure, for example catching a wave at high-speed or sailing with the wind on the beam.

The analysis programs transmit relevant information which are compared to nominal values in the specs. **Colour displays are particularly instructive in sample determination**.

The overall research programme aims to define type and quantity of construction materials best **suited to each zone** in order to eliminate unnecessary weight and apply suitable safety margins to load bearing elements.

High strength rigid foam

Isophthalic polyester resin with 1st layer of vinylester (better protection against osmosis)

Rigidity

Set of infused bulkhead : Important rigidity due to the structure itself and the manufacturing process

Many advantages:

- Closed cells = hydrophobic
- Limit the twists
- Lighter and more dense than balsa (easier to repair)



NEEL 43 initiates the use of bio-sourced and recyclable materials.

- Development of a glass-linen complex
- Use of recyclable P.E.T foam
- Use of isophthalic polyester resins used for infusion, they offer a better mechanical, chemical, thermal and wet resistance and a better aging



Cork

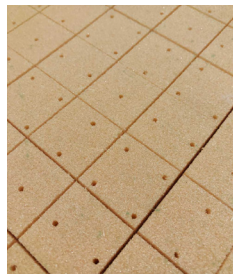

*Recyclable
P.E.T foam*



*Linen/glass
complex*

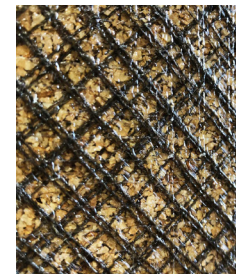

*Linen/glass
complex*

These materials represent 30% of the composite surfaces of NEEL 43.

Watch the [Youtube playlist](#) on the quality approach at NEEL-TRIMARANS

Registered innovations and modularity

Full Beam Cockpit®

3 to 5 cabins

Modular spaces



Flush area of 22 m²
fully protected with
roof

**Modularity of
opening** (multi-position
of the sliding doors)

Possibility to gather up
to **10 people** around 2
tables

2 distincted areas
Around tables
Private face-to-face

Safety and fluidity
of circulation with no
rigging on the cockpit



EASY CIRCULATION PLAN ONBOARD

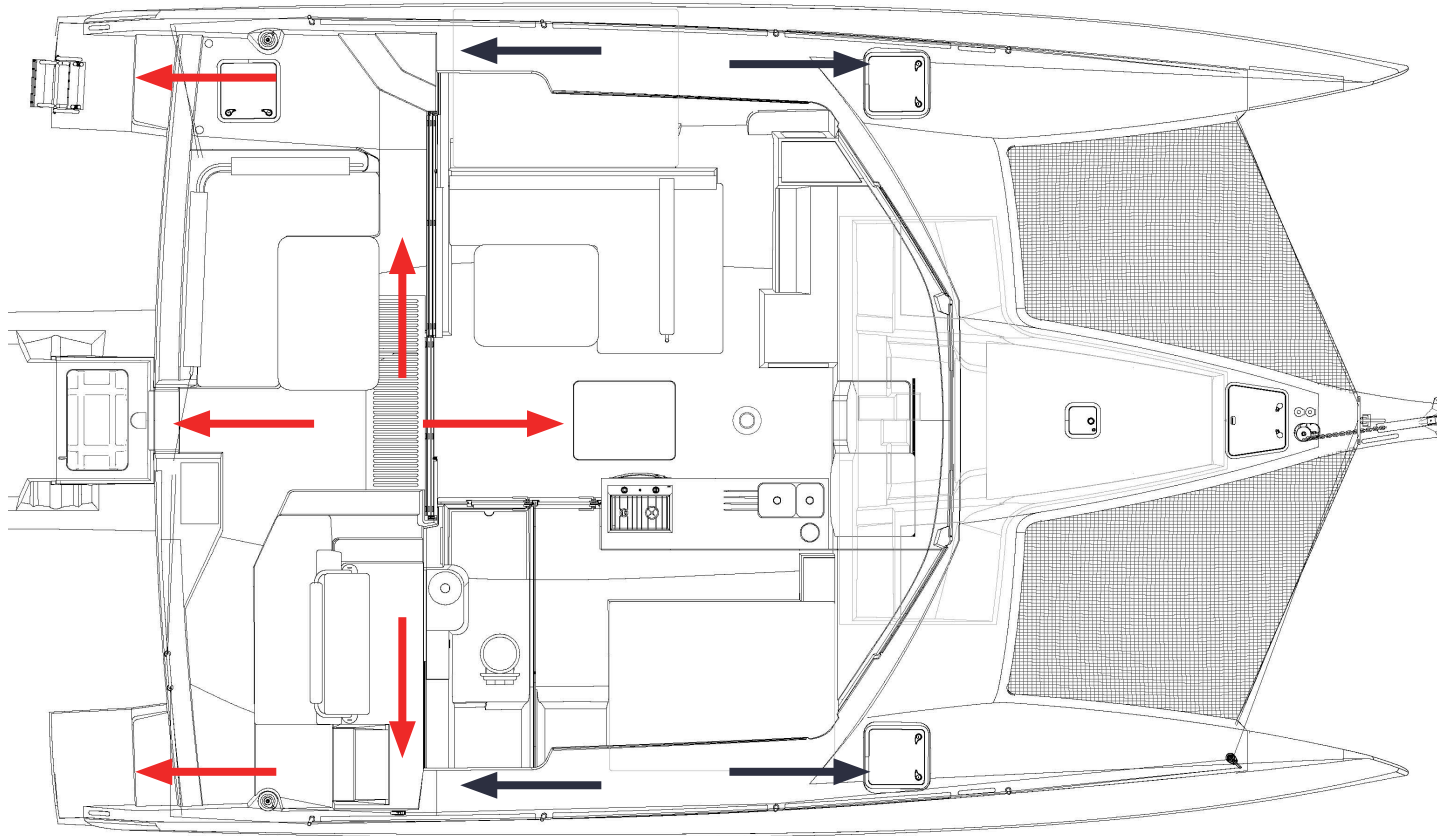

Increased safety and smoother traffic flow on the bridge thanks to more space

 Easy and safe circulation + central access to helm station and transom

 Very secured catwalks « interior passages » with turnbuckles fixed on the deck, freeing the passage



Centralized:

All manoeuvres are carried out at the helm station: mainsail, sheeting, reefing....

Comfortable and convivial:

2 to 3 people can stand near the helm station without embarrassment



Secured:

- Direct and secure access from the cockpit to the helm station
- Excellent visibility for manoeuvres

Usable space

Solar panels
Sunbathing on the roof
at anchor
Easy access to boom

Flush area **360°
visibility** at the helm
station

All control lines led
back to helm station for
a **solo** or **shorthanded**
sailing



Up or down table



Comfortable and friendly
living space

Modern
open
ventilated
bright

Panoramic view
Ergonomics
Numerous storage spaces
Conviviality on board



**INTEGRATE PLANCHA
IN THE COCKPIT
(OPTION)**



270° panoramic view

Extra large window

Possibility to vary the atmosphere with a set of blinds : cozy and intimate or bright and open

Ventilated space



A large space dedicated to several functions:

- WC
- Shower
- Storage of sea clothes

Directly accessible from the cockpit

Generous, ergonomic and functional

Fully polyester wet cell



NAVIGATION STATION FACING THE SEA

Facing the route

Conviviality integrated in the saloon.

seat convertible into a child's bed
(ensuring proximity to the parents' cabin)

Excellent visibility at night



Double bed on port side of saloon

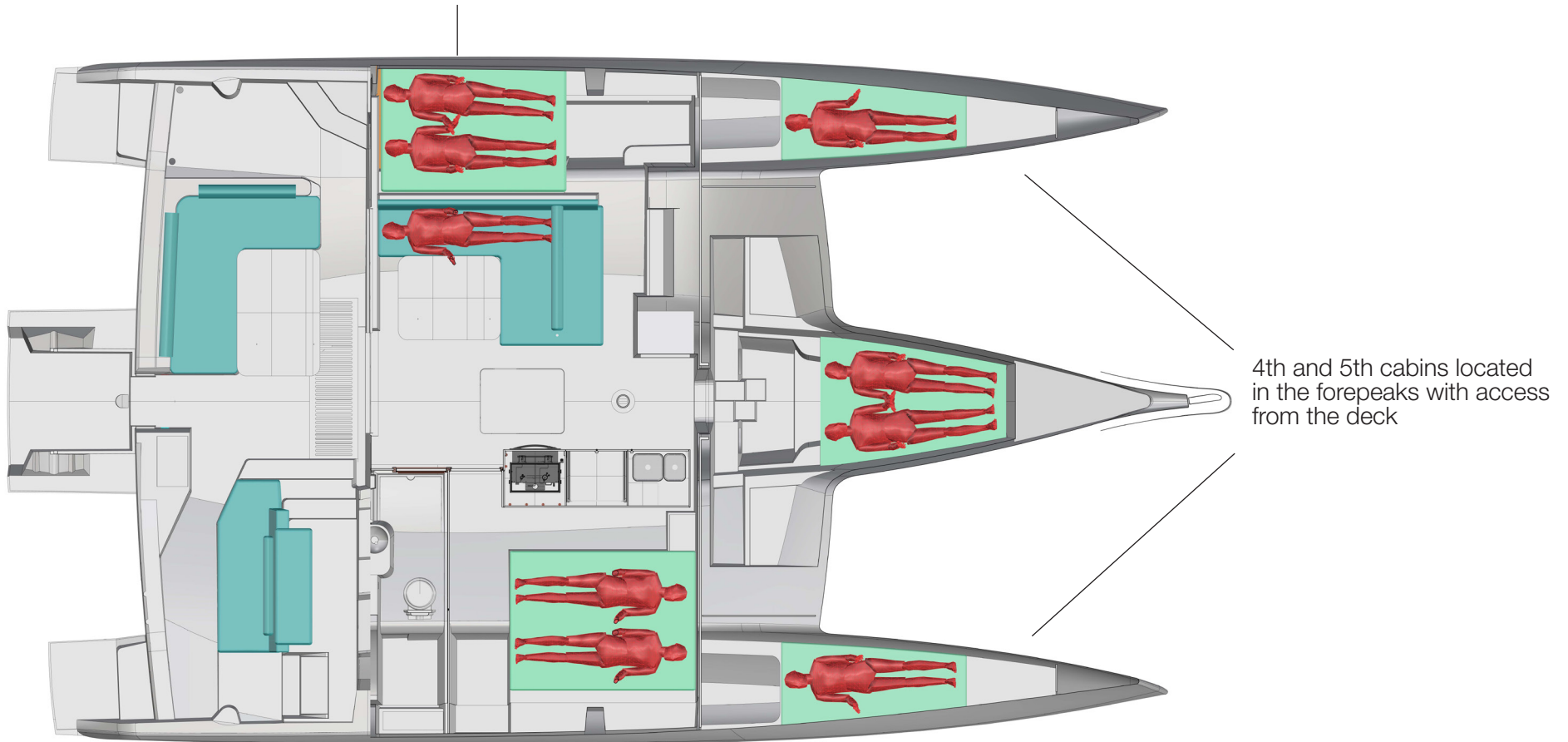

4th and 5th cabins located in the forepeaks with access from the deck



Six independent sleeping areas

Owner's cabin **on the same level** : 2 pers.

Front cabin central float : 2 pers.

Port cabin with double berth 140x200 which can be hidden by a curtain : 2 pers.

Night space in the saloon with **double bed** surrounded by a curtain : 2 pers.

XXL front peaks that can be converted into sleeping quarters : 2x1 pers.

Double berth saloon



Double berth space:

- During the day: secure park for young children
- At night: private space with curtains drawn



FRONT CABINS (OPTIONAL)

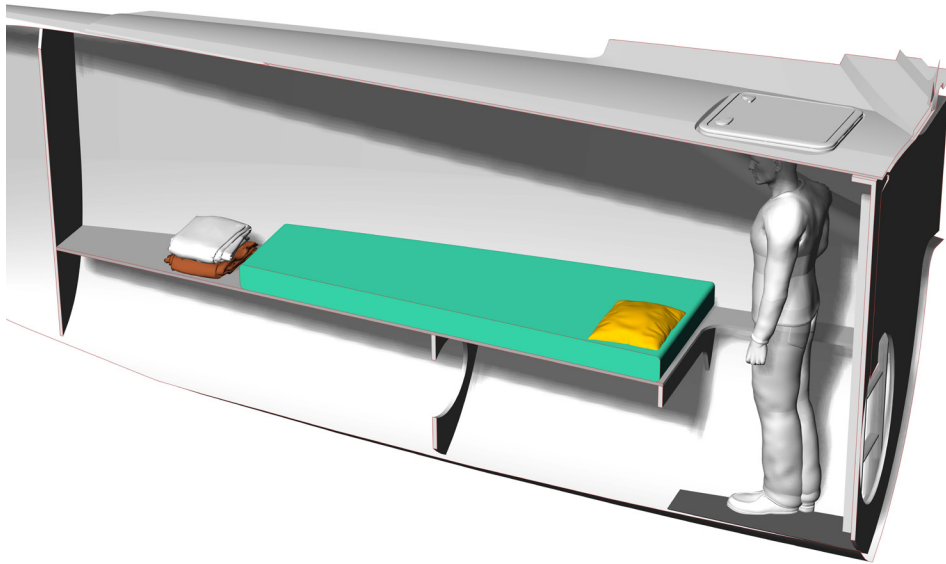

A front cabin that offers a true adult berth

A standing area in front of the bench

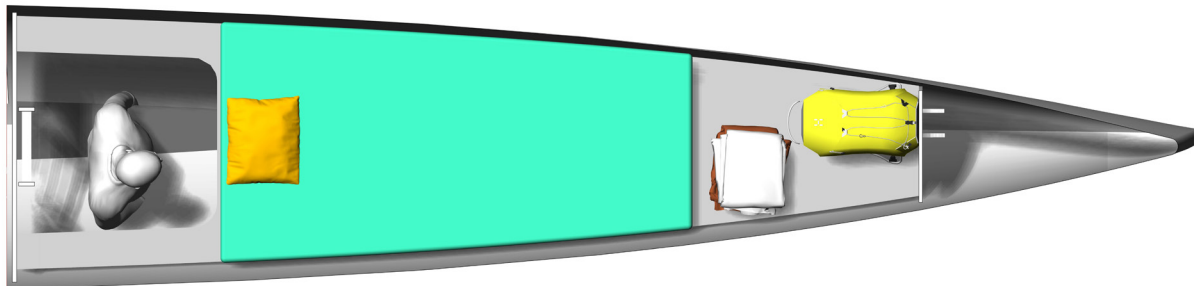

Central technical area allowing the centering of the weights
for a better navigation comfort
Real «workshop» and storeroom
Easy access to technical areas

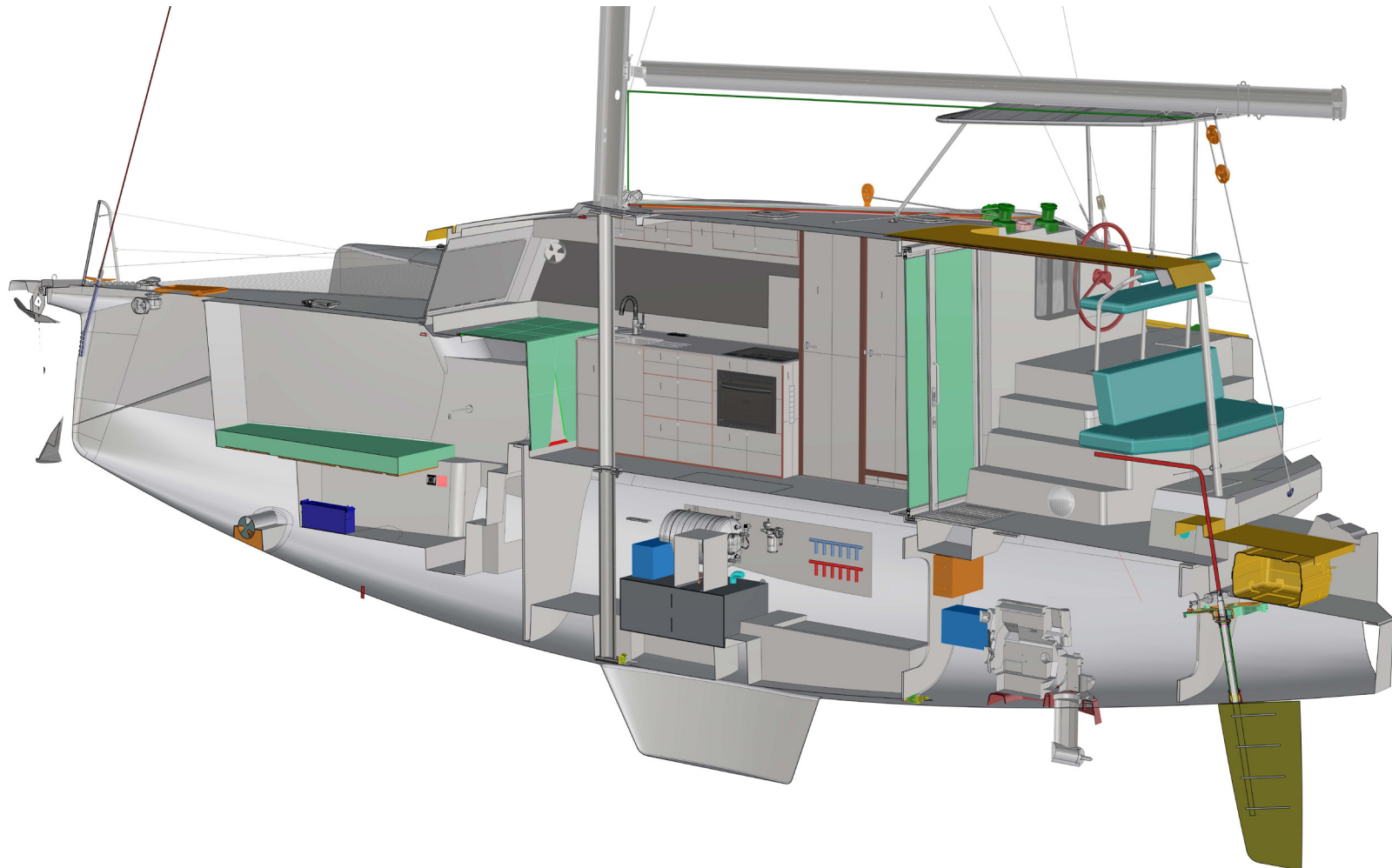



**Deep anchor locker and access to bow thruster
at the front of the central float**

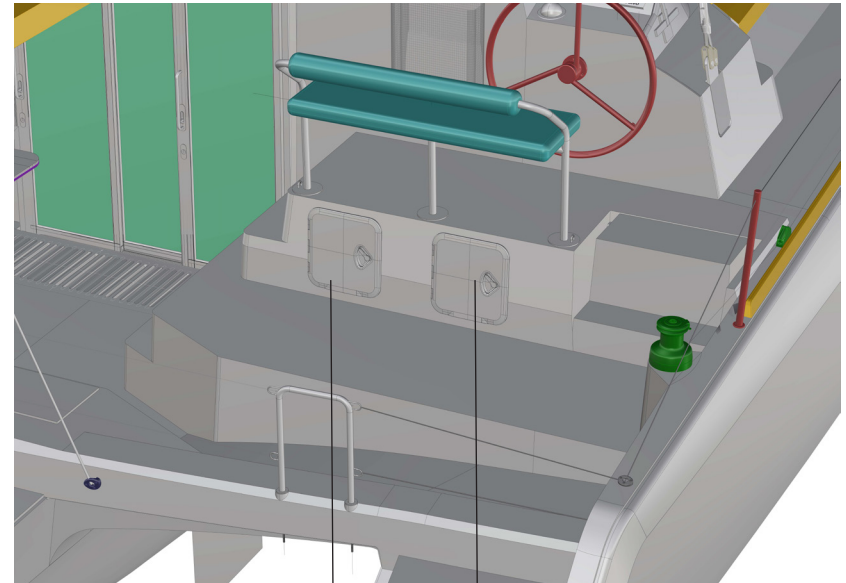

**Gas boxes for
storage and reserve**

TECHNICAL AND STORAGE AREAS

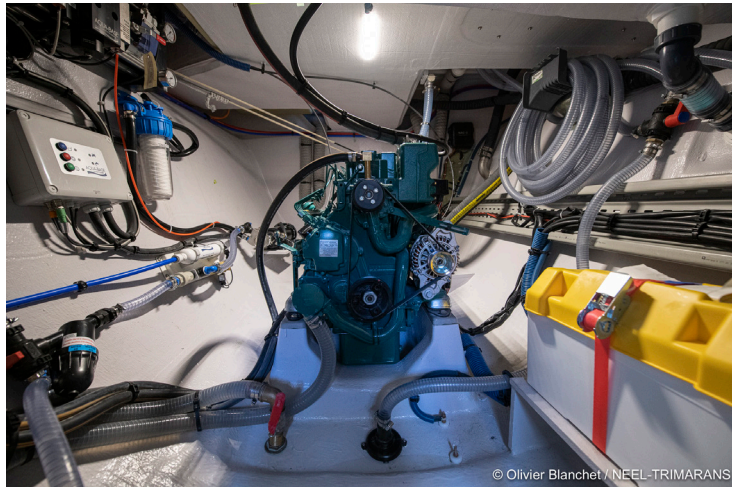

Engine bay with direct access
from the technical area



Two large aft storage lockers
(port and starboard)



Releasable staysail forestay
(optional)

- Possibility of installing a carbon mast (optional) thanks to the performance rigging.
-
- Set of 2 sails allowing to sail in all conditions.
-
- Helm station with all the maneuvers to facilitate short-handed sailing
-
- Very good feeling at the helm thanks to a pulley system and textile steering lines reducing any friction.
-
- Titanium anodized aluminum stanchion rail and fluorescent Dyneema® ropes.

Un propulseur **ultra efficace**.
Il ne renvoie pas le flux sur les autres flotteurs



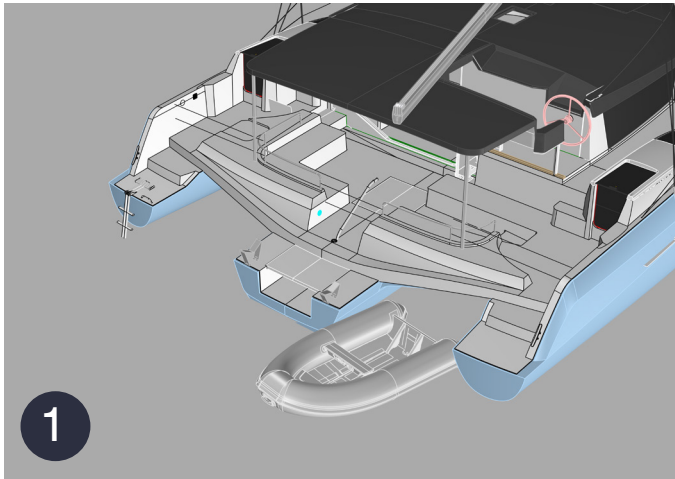

Saving space at the back
thanks to the absence of a davit

Easy to maneuver alone with the remote
control

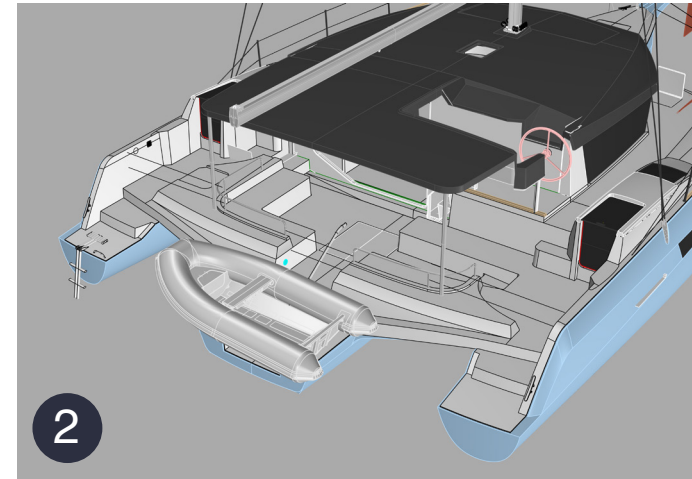

Raising and lowering of the dinghy by a modern and
easy to use system thanks to :

- The topping lift
- The boom serving as a crane
- The remote control
- The bers

[Video tutorial on Youtube](#)

SIMPLE

EFFICIENT

QUICK

NEEL-TRIMARANS HULL VS. CATAMARANS AND MONOHULLS

Le meilleur des
deux mondes



The catamarans constraint is to find the compromise between:

- floats that are either very «rocky» to facilitate change tack
- or have very tight floats to avoid pitching.

The trimaran offers both a rocky shape main hull (facilitating the tacking) and very **tight floats** (no pitching and therefore a real comfort at sea).

Only the trimaran tacks as easily as a monohull (thanks also to its staysail on a drop-down forestay).



Dimensions

Overall length	43 ft
Overall width	24,60 ft
Draught	4,95 ft
Air Draft	62 ft
Light displacement	9 T
Full battened mainsail	630 sq. ft
Genoa	466 sq. ft
Water tank	430 L / 113 US G.
Fuel tank	275 L 72,6 US G.
Engine sail drive	50 HP

Design et conception

Architects	Marc Lombard, Yacht Design Group
CE Certification	ICNN
Conception	NEEL-TRIMARANS



Number of people on board (CE)

Category A	8
Category B	10
Category C	20
Category D	20

Overall beam
(m)

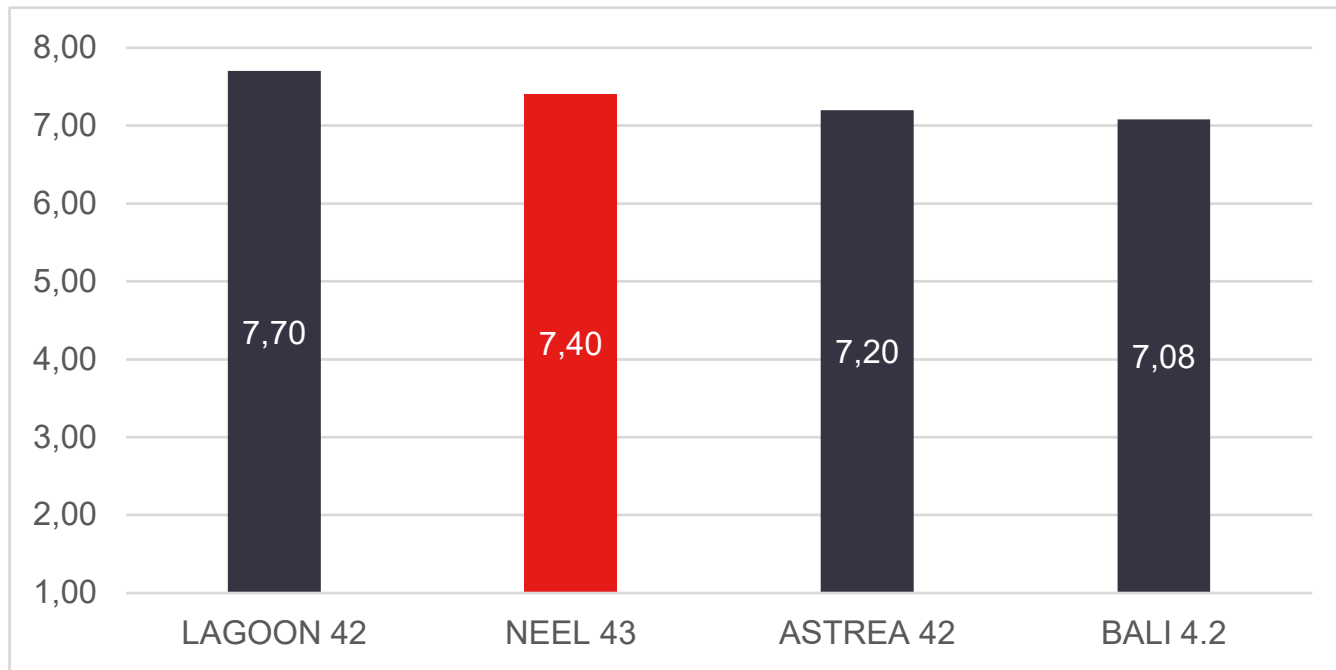

The NEEL 43 is only 20
cm wider
than an ASTREA 47
(2021 information)

POWER TO WEIGHT RATIO

Power-to-weight ratio is used to measure the performance of the boat.

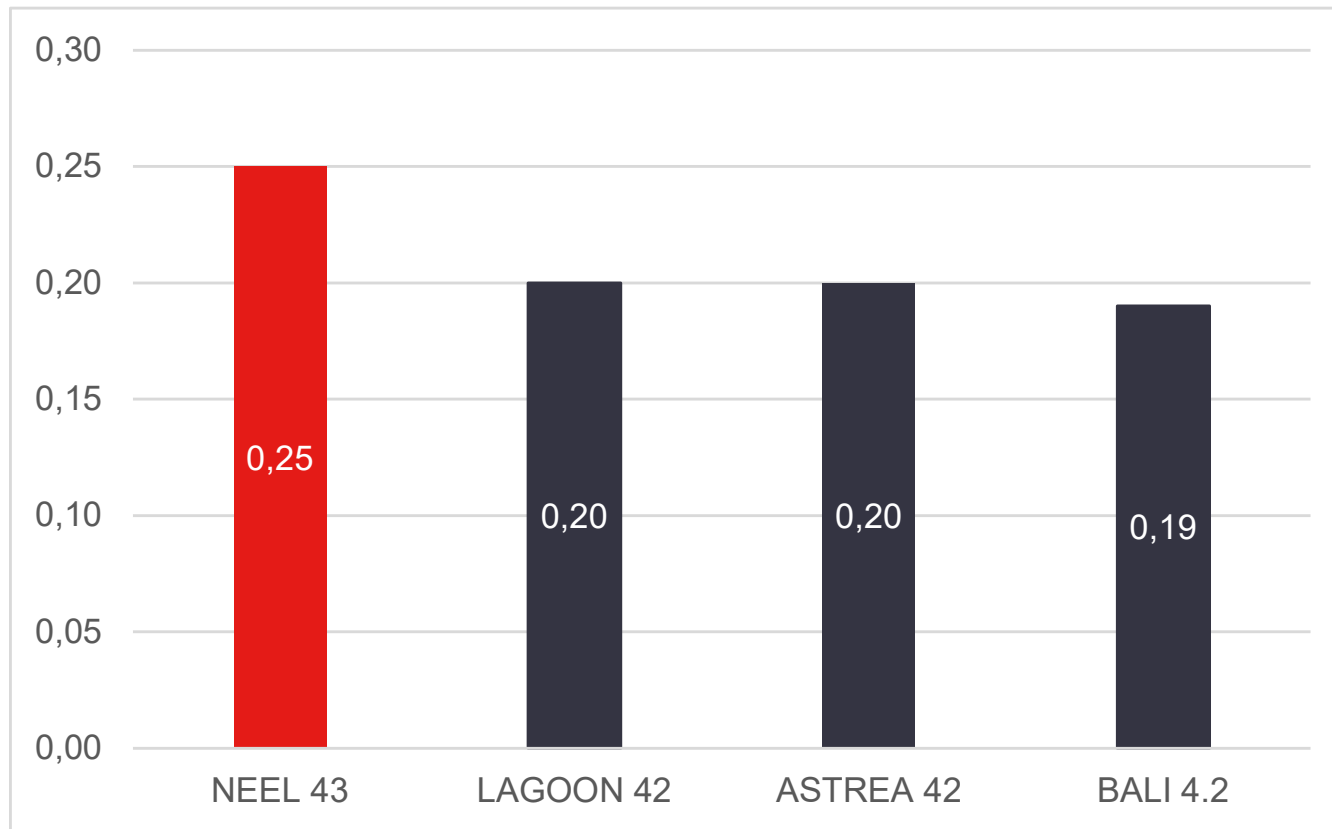

The NEEL 43 offers the best power-to-weight ratio (2021 information)

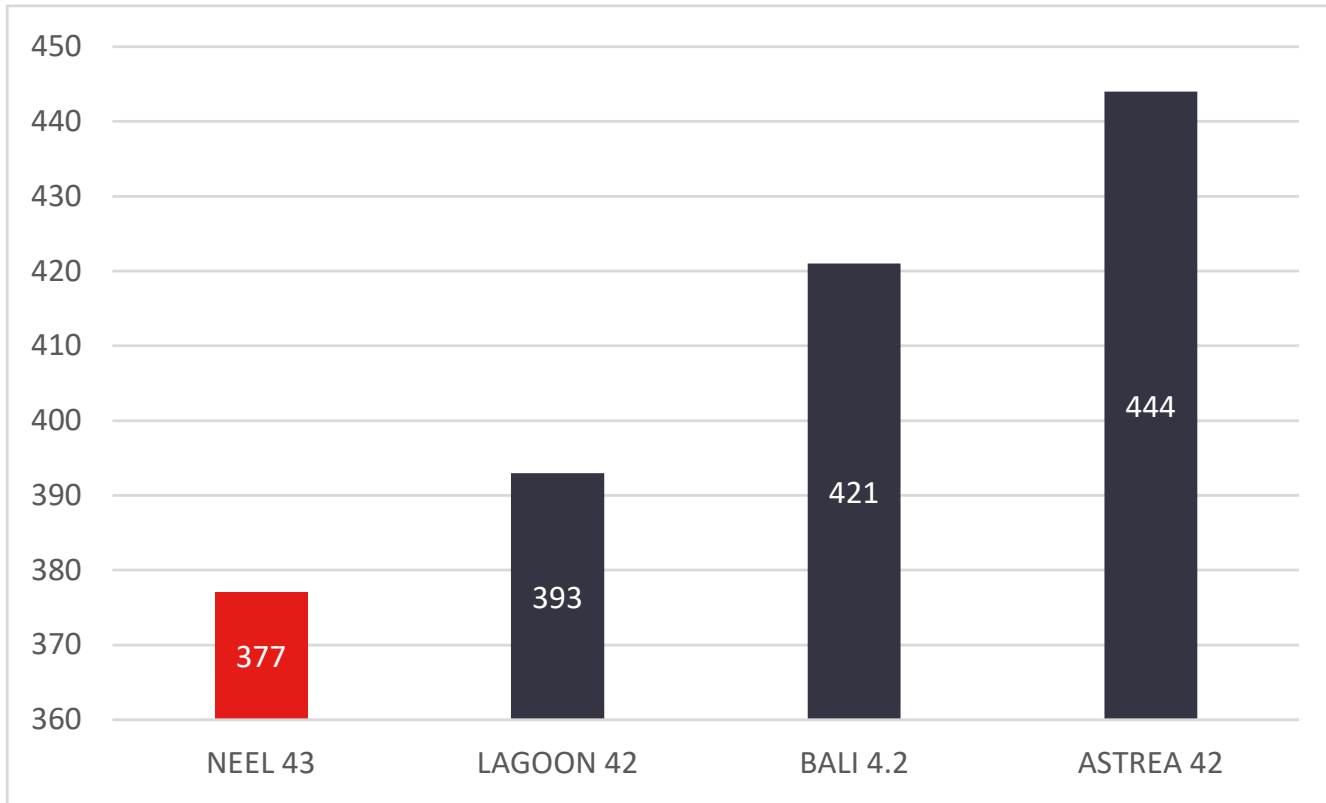

Comparison with equivalent configuration, ready to sail. (2021 information)

The NEEL 43 remains the most accessible

NEEL 43

SAFETY

PERFORMANCE

MODERNITY

MODULARITY

CONVIVIALITY

EASY CIRCULATION

QUALITY CONSTRUCTION

ATTRACTIVE PRICE





Yannick Bestaven, winner of the 2020-2021 Vendée Globe,
godfather of the NEEL 43

«The whole range of NEEL trimarans is superb, just like its designer Eric Bruneel, whom I appreciate very much. The NEEL 43, the latest model, of which I am the happy godfather today, has all the assets of its predecessors. A beautiful boat on which it will be good to live, like at home! I can already see myself on board during my next cruises! Thank you to the shipyard and all the production teams. I am very proud to represent your know-how.»

**JUST
MAKES
SENSE.**

NEEL-TRIMARANS
4 rue Virginie Hériot
17000 LA ROCHELLE
sales@neel-trimarans.com
www.neel-trimarans.com